

Forme · Formes · Shapes · Formen · Formas

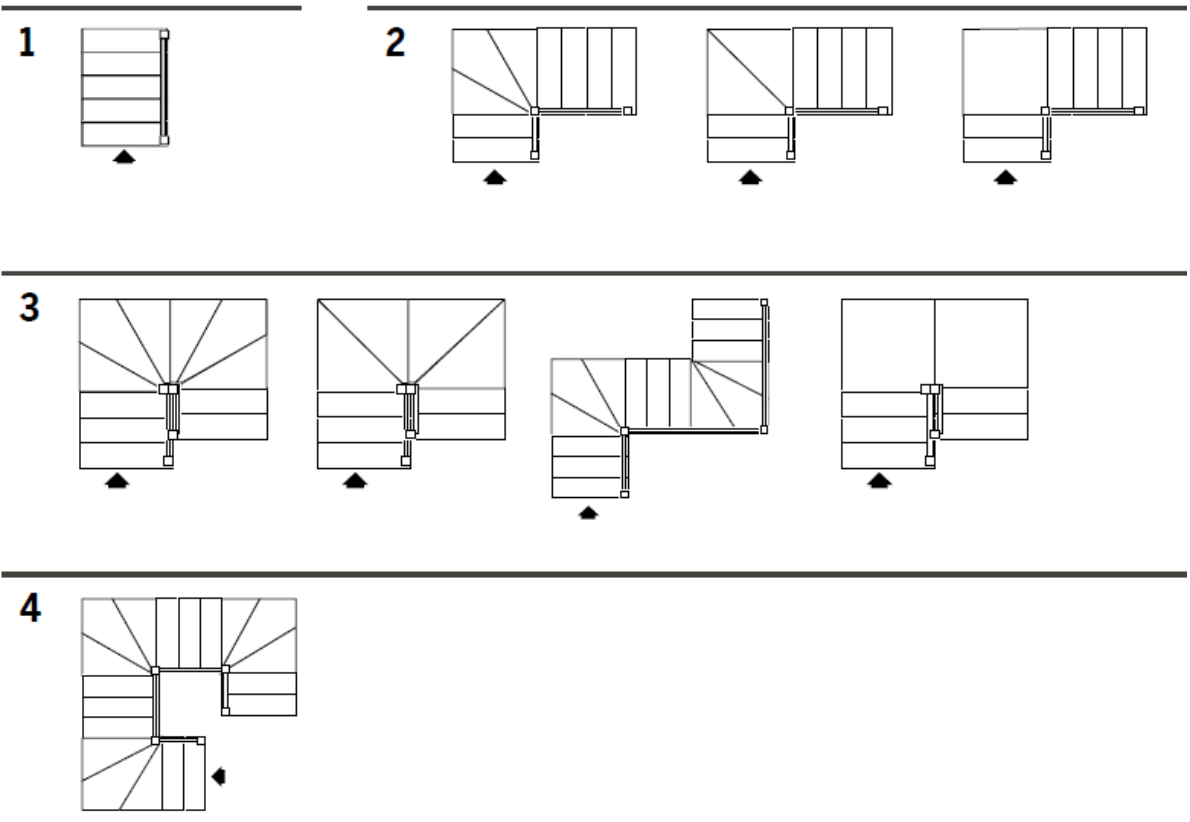

	G10	G11	G12	G13	G14	G15	G16	G17
h	1870	2040	2210	2380	2550	2720	2890	3060
	2310	2520	2730	2940	3150	3360	3570	3780



LE FORME DELLA STRUTTURA

Shapes of the structure
Formes de la structure
Die Formen der Strukturen
Las formas de la estructura

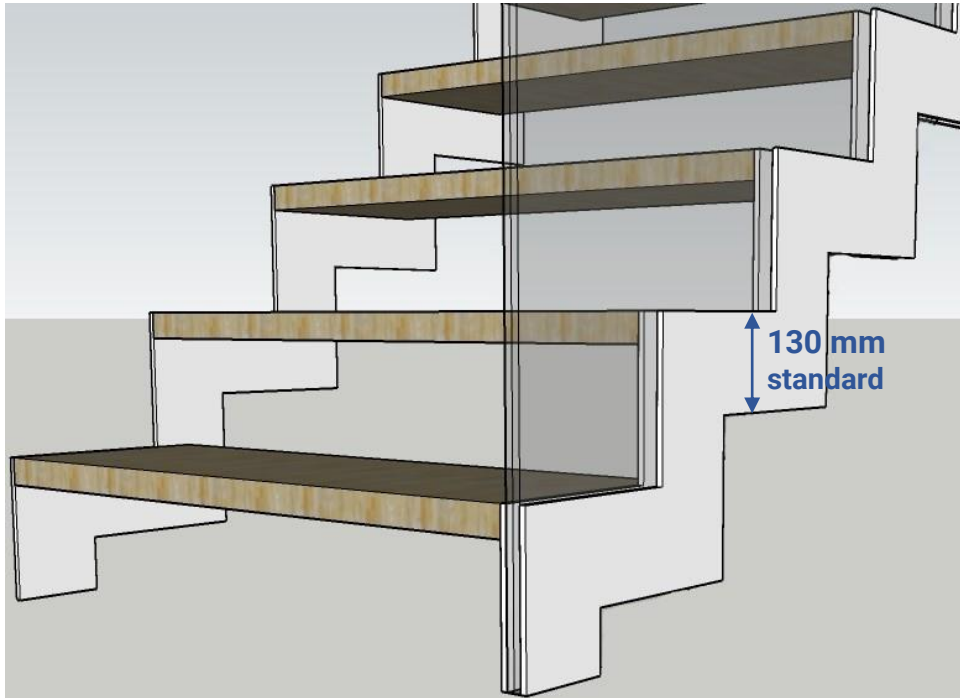

Z
(standard)

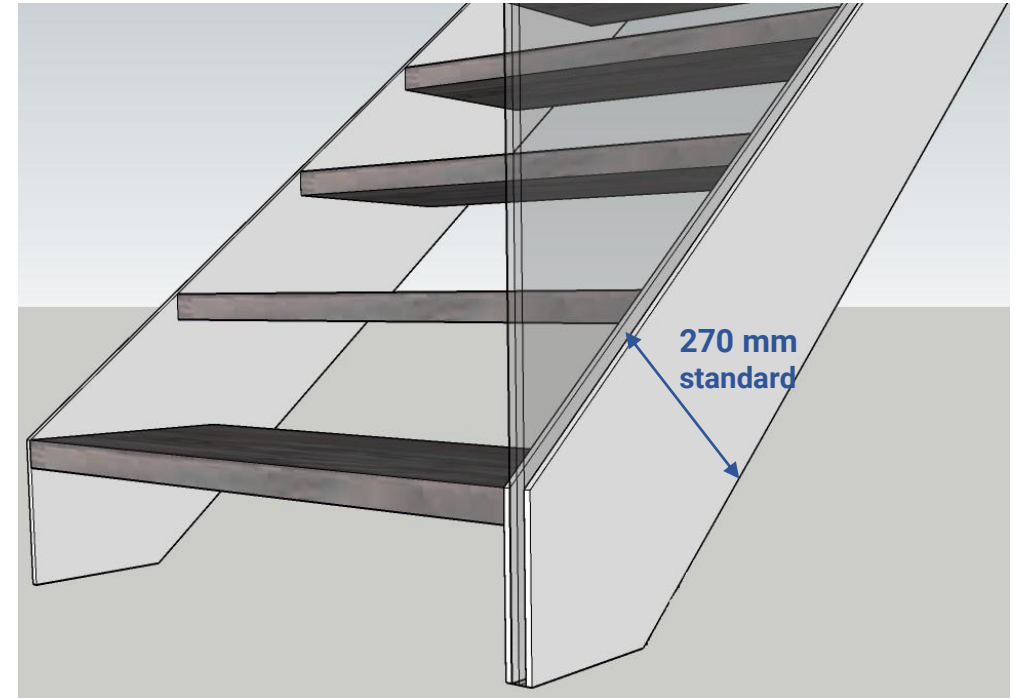

L
(optional)

Caratteristiche tecniche

Technical specifications
 Spécifications techniques
 Technische Daten
 Características técnicas

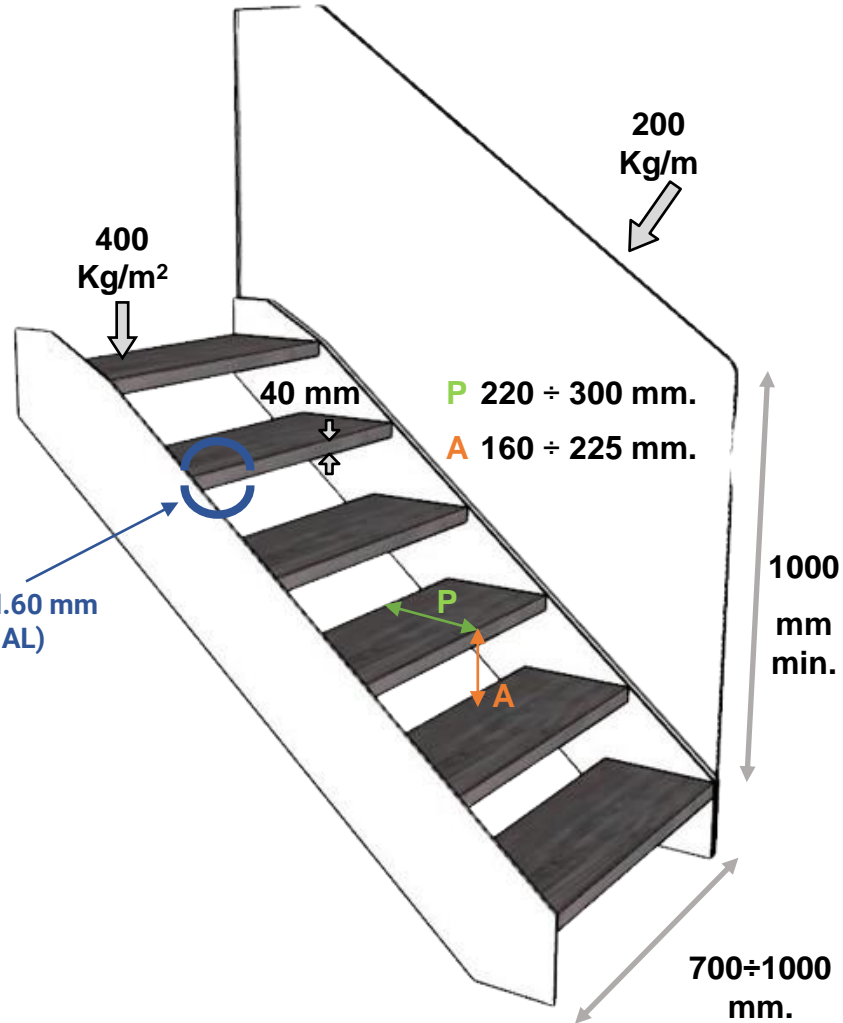

Tipologie di legno

Type of Wood
 Type de bois
 Holzart
 Tipo de madera



Faggio
 Beech
 Hêtre
 Buche
 Haya



Rovere
 Oak
 Chêne
 Eiche
 Roble

Calcolo passaggio utile

Useful passage - passage utile
 nützliche Passage - Pasaje útil

L - R (31,52mm) = P

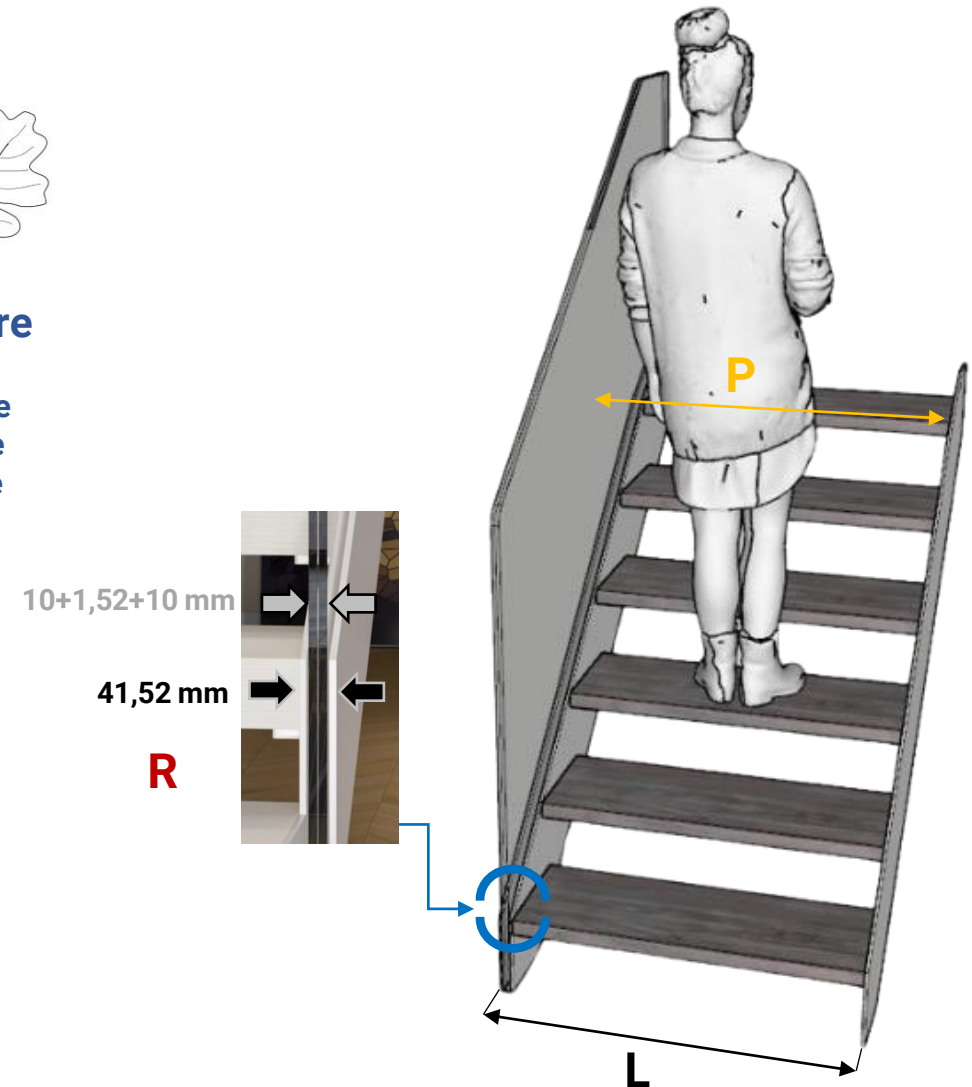

ARRIVO CON ALZATA
ARRIVAL WITH RISER
ARRIVÉ AVEC HAUTEUR
ANKUNFT MIT STEIGUNG
LLEGADA CON CONTRAHUELLA

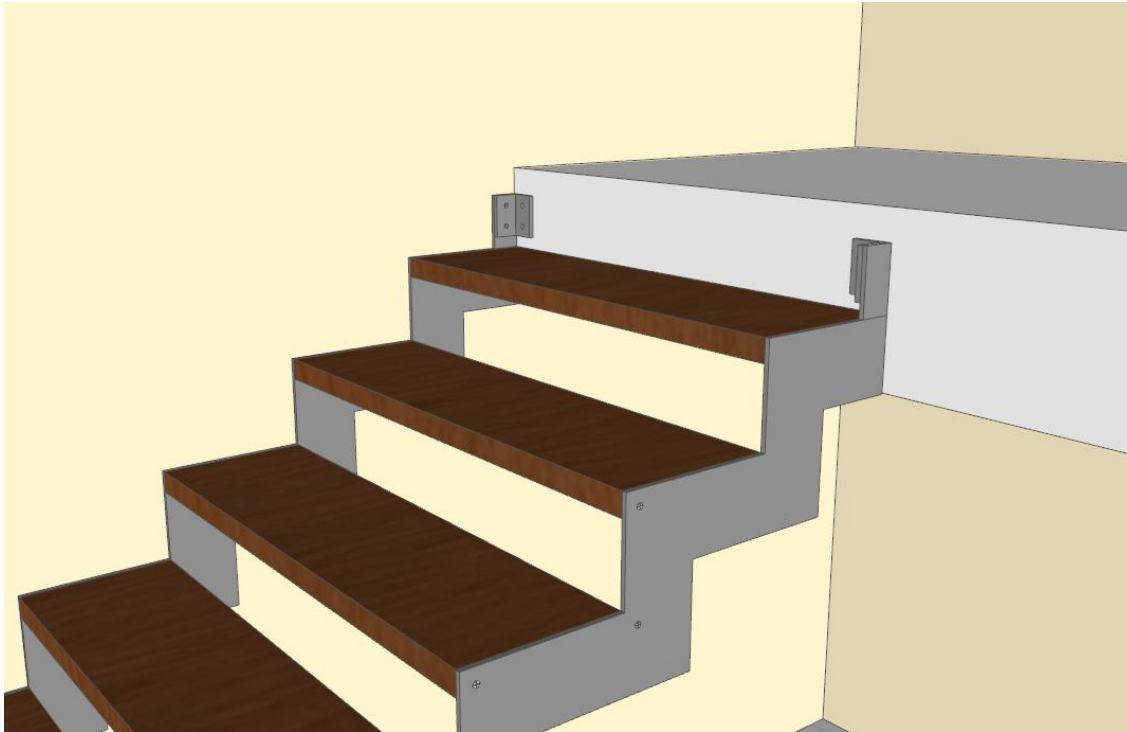

ARRIVO PARI PAVIMENTO
ARRIVAL AT SAME FLOOR LEVEL
ARRIVÉE AU MÊME NIVEAU DU SOL
ERREICHUNG GLEICHEN NIVEAU DES BODENS
LLEGADA MISMO NIVEL QUE EL SUELO

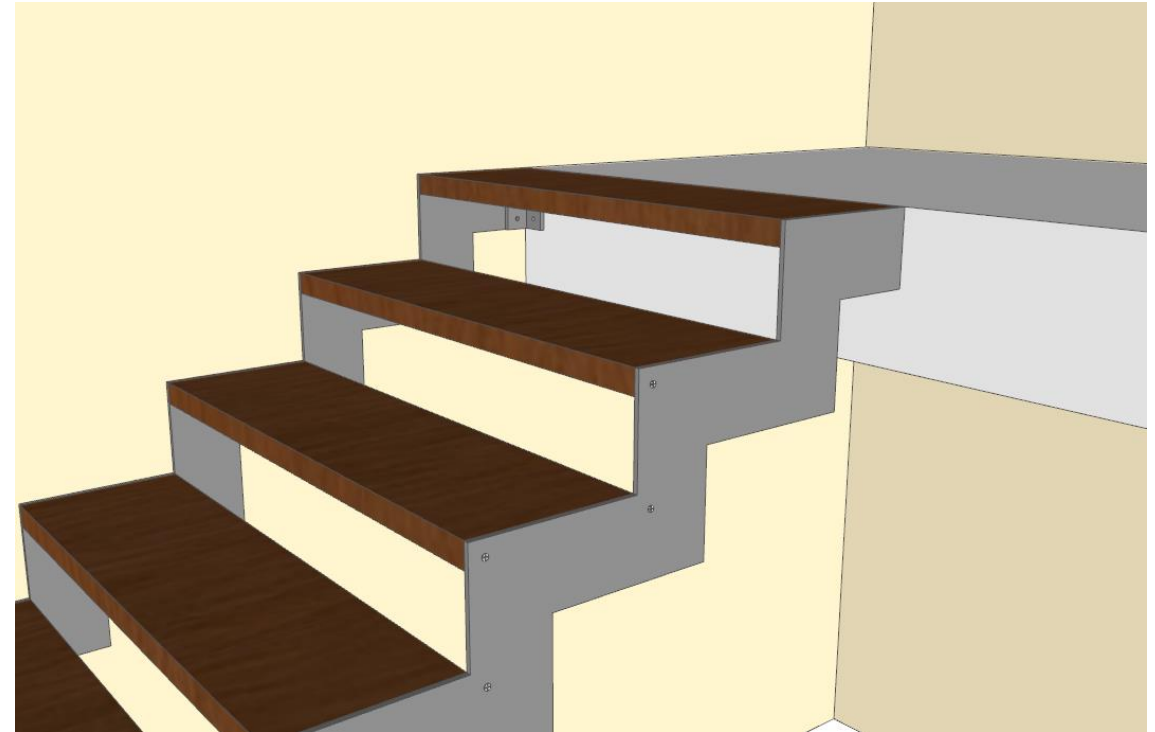

PARTENZA DA PAVIMENTO

Floor Departure – Départ du sol – Abfahrt der Treppe vom Boden
Salida de la escalera del suelo

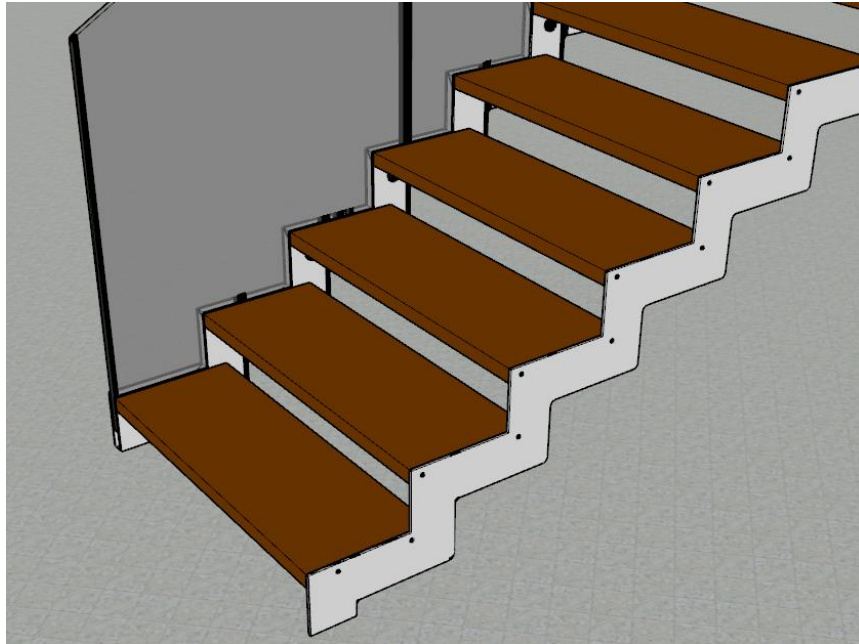

PARTENZA A SBALZO

Cantilever stair departure – Départ escalier en porte-à-faux
Abfahrt Kragarmtreppe - Salida de la escalera en voladizo

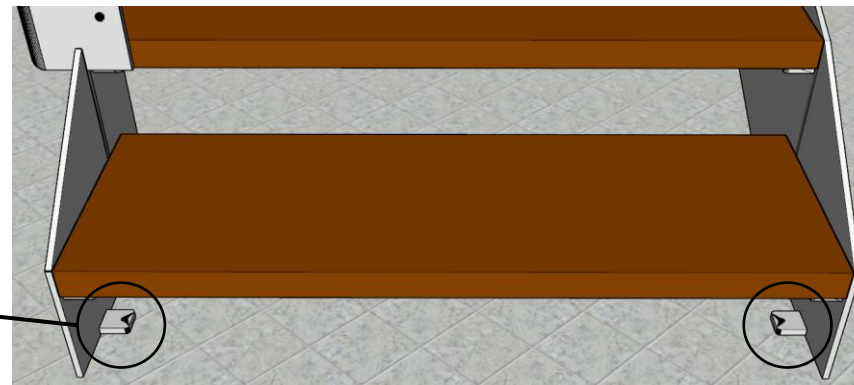
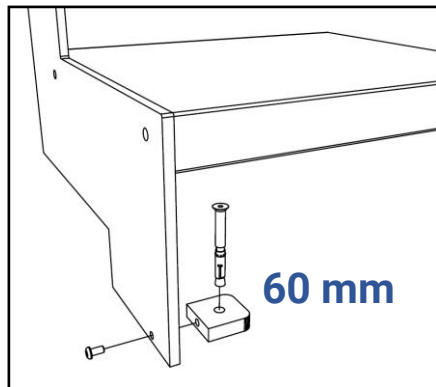
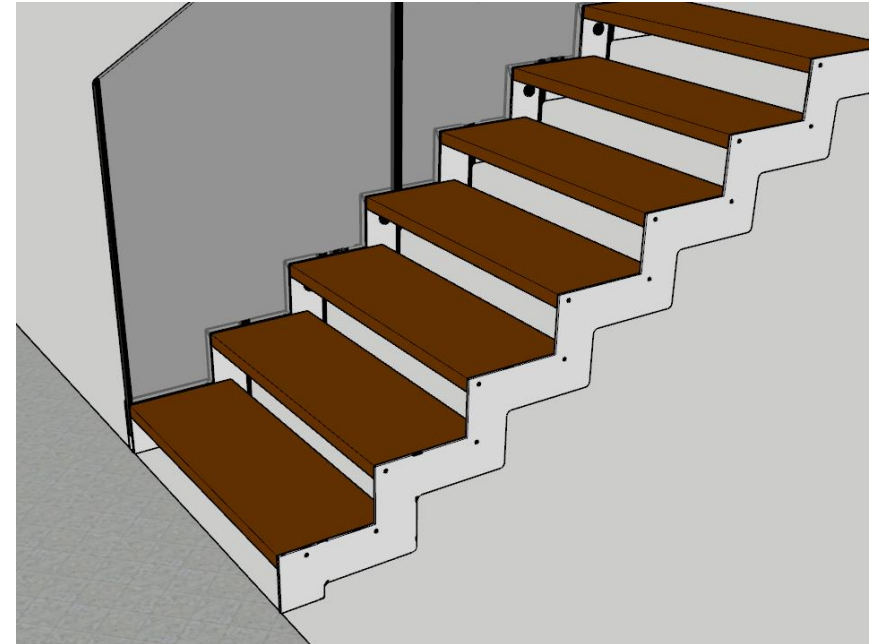

BALAUSTRE DISPONIBILI

Floor protection balustrade – Garde-corps de protection –
Schutzgeländer - Barandillas de protección

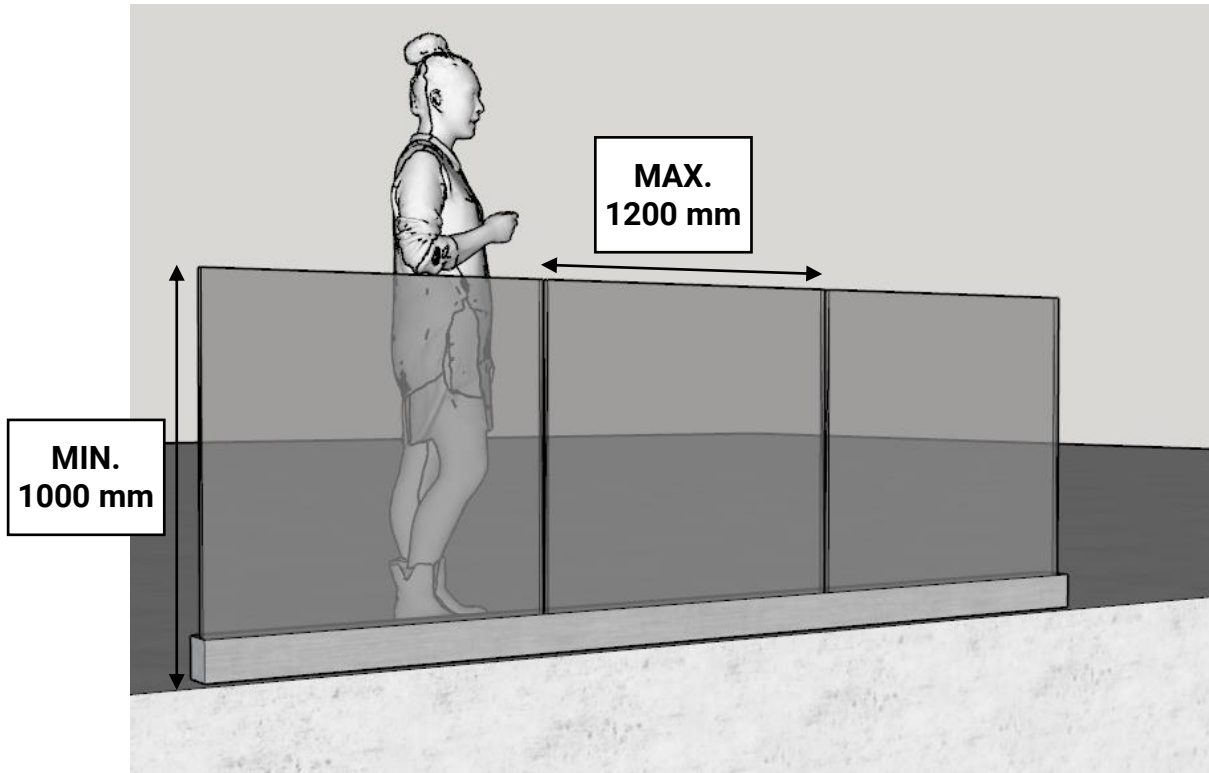

TRACK P

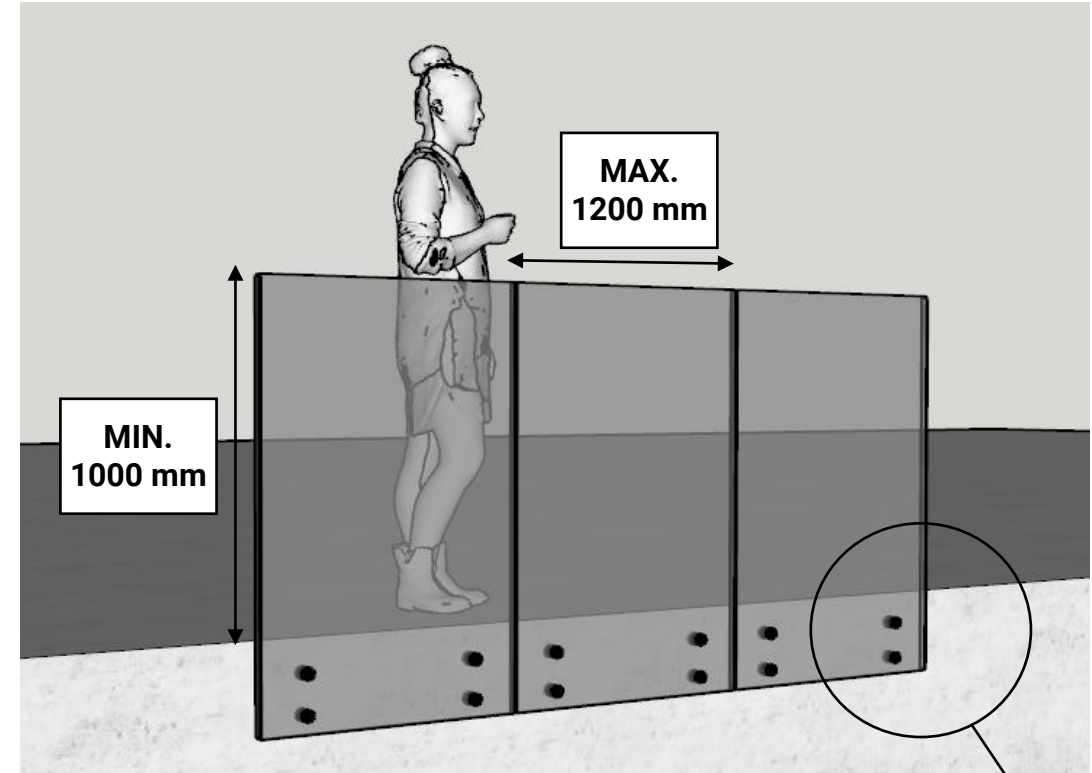

XR

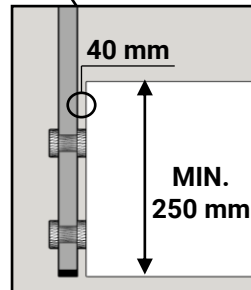

Alzate chiuse

Closed Risers – Contremarches
Setzstufen – Contrahuella cerrada

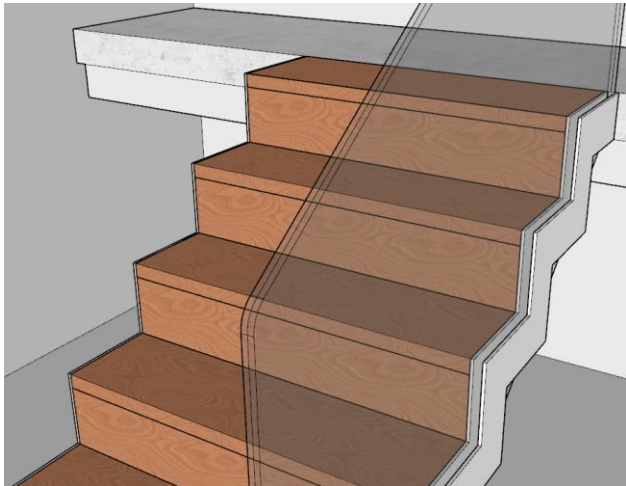

Angolo per pilastro (max 3 gradini)

Corner for Pillar (max 3 steps) – Angle pour Poteau (max 3 marches)
Winkel pro Säule (Max 3 Stufen) - ángulo por pilar (máximo 3 escalones)

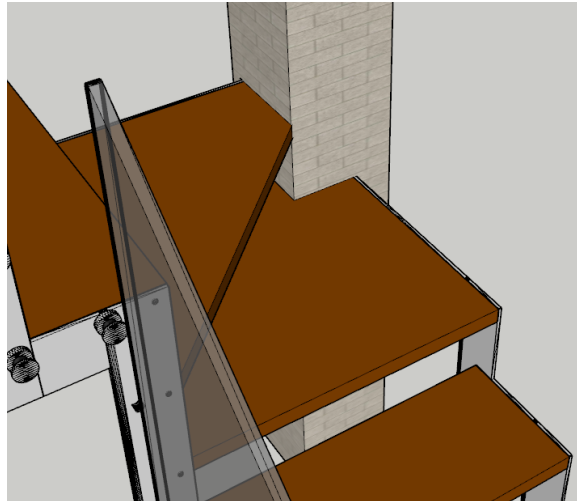

Scala fuori squadra

Out-of-square stair – Escalier hors équerre
Unregelmäßige Treppe – Escalera fuera de escuadra

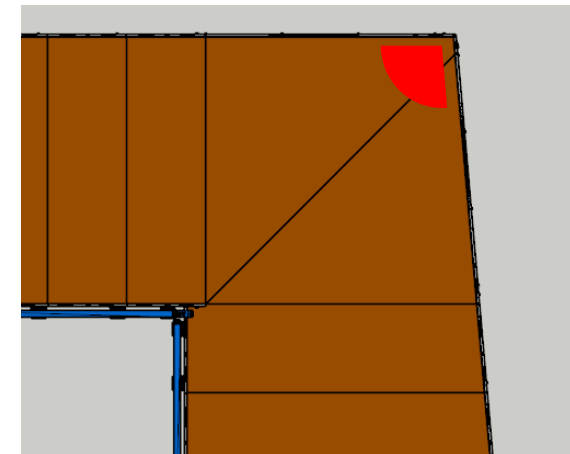

Corrimano a muro

Wall handrail – Main courante murale
Wandhandlauf - Pasamanos de pared



Larghezza scala

Staircase width – Largeur escalier
Breite der Treppe - Ancho de escalera

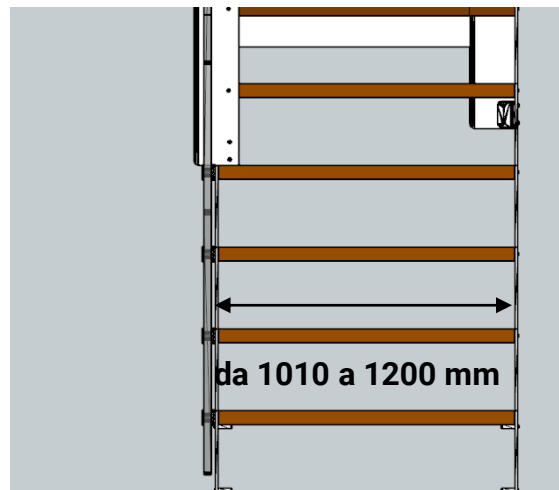

Soglia

Threshold – Seuil – Schwellenwert - Umbral

